

Range
—
ZET



—
PRICELIST
PRESS

—
EXPORT
01.06.2024



Range

ZET

ZET is a light and elegant range, designed in collaboration with norwegian RIIS Interiør from Oslo. The furniture is as standard made of ash wood, with a tight and cubic steel frame.

Designed by

Else Marie Risøe Evensen
(*Riis Interiør*)



This range include

Dining tables | Coffee tables
Sideboards | HIFI sideboards
Cabinets | Benches
Shelf furniture | Desks
Console tables | Nightstands
Sidetables

Features



Design elements

Choose between different designs on plates and legs.



Custommade

In addition to our many standard sizes we can accommodate special requests.



Wood colours

Choose between more than 10+ different wood colours in both ash and oak.



Sustainable choice

Solid wood furniture can last a lifetime with proper maintenance

Social media

Follow and share with us on Instagram.



@kristensenfurniture | #kristensenfurniture

Pricelist- and imagebank

On our Collection-site you as a retailer always have access to the latest pricelists and hundreds of high resolution images and videos - **Free to use in your marketing!**

If you do not have a password yet, please contact the Kristensen sales office in Denmark.

LINK:

collection.kristensen.com

PRICELIST

Round dining table w/ or w/o middle extension and angled legs

—



Additional information

—

Special orders larger than standard may be too unstable.

- Max diameter is 160 cm, sizes above become too unstable.

Plate thickness: 3 cm.

Steel profile: 3x3 cm.

Item no. 641V

Round dining table w/angled legs (plate thickness 3 cm)				
Size (cm)	Price (EUR)			
	Without middle extension		With middle extension	
	Ash	Oak	Ash	Oak
D160 H74 cm	1.201	1.539	1.383	1.772
D150 H74 cm	1.040	1.333	1.202	1.540
D140 H74 cm	827	1.059	972	1.245
D130 H74 cm	740	948	846	1.084
D120 H74 cm	648	830	735	941
D110 H74 cm	587	751	668	855
D100 H74 cm	531	680	606	777

1-4 leaves
2 support legs are provided for tables in the size of 150-160 cm.

1 leaf

* Comes with 2 support legs

Leaf for tables with middle extension		
Size (cm)	Price (EUR)	
	Item no. 631	
	Plate in quality as the table	
	Ash	Oak
45x160 H3 cm	188	240
45x150 H3 cm	178	229
45x140 H3 cm	166	213
45x130 H3 cm	158	203
45x120 H3 cm	155	199
45x110 H3 cm	152	195
45x100 H3 cm	149	191

Stainless steel = + 10%

All prices are purchase prices in Euro.
We accept no liability for any errors or omissions.

PRICELIST

Round dining table w/ or w/o middle extension and straight legs



Additional information

Special orders larger than standard may be too unstable.

- Max diameter is 160 cm, sizes above become too unstable.

Plate thickness: 3 cm.

Steel profile: 3x3 cm.

Item no. 641

Round dining table w/straight legs (plate thickness 3 cm)				
Size (cm)	Price (EUR)			
	Without middle extension		With middle extension	
	Ash	Oak	Ash	Oak
D160 H74 cm				
D150 H74 cm				
D140 H74 cm				
D130 H74 cm				
D120 H74 cm				
D110 H74 cm				
D100 H74 cm				

 1-4 leaves
2 support legs are provided for tables in the size of 150-160 cm.

 1 leaf

* Comes with 2 support legs

Leaf for tables with middle extension		
Size (cm)	Price (EUR)	
	Item no. 631	
	Plate in quality as the table	
	Ash	Oak
45x160 H3 cm		
45x150 H3 cm		
45x140 H3 cm		
45x130 H3 cm		
45x120 H3 cm		
45x110 H3 cm		
45x100 H3 cm		

Stainless steel = + 10%

All prices are purchase prices in Euro.
We accept no liability for any errors or omissions.

PRICELIST

Rectangular coffee table



Item no. H45: 6341

Item no. H52: 6342

Coffee table Price (EUR)						
Ash H45 or H52 cm						
L 140						
130						
120						
110						
100						
90						
80						
	60	70	80	90	100	110

Coffee table Price (EUR)						
Oak H45 or H52 cm						
L 140						
130						
120						
110						
100						
90						
80						
	60	70	80	90	100	110

Additional information

Plate thickness: 2 cm.

Steel profile: 2x2 cm.

Alternative size = surcharge.

Stainless steel = + 10%

All prices are purchase prices in Euro.
We accept no liability for any errors or omissions.

PRICELIST

Round coffee table



Item no. H52: 6392

Item no. H45: 6391

		Round coffee table Price (EUR)								
		Ash								
H 52										
45										
	D	36	42	48	54	60	66	72	78	84

		Round coffee table Price (EUR)								
		Oak								
H 52										
45										
	D	36	42	48	54	60	66	72	78	84

Additional information

Special orders larger than standard may be too unstable.

Plate thickness: 2 cm.

Steel profile: 2x2 cm.

Alternative size = surcharge.

Round coffee tables are delivered assembled.

Stainless steel = + 10%

All prices are purchase prices in Euro.

We accept no liability for any errors or omissions.

PRICELIST

Console table w/ or w/o shelf

—



Item no. 636

Console table Price (EUR)						
Dimensions (cm)			Ash		Oak	
W	D	H	w/"V"	w/shelf	w/"V"	w/shelf
100	30	80				
110	30	80				
120	30	80				
130	30	80				
150	30	80				
200	30	80				

Additional information

—

Console tables are delivered assembled.

Stainless steel = + 10%

All prices are purchase prices in Euro.

We accept no liability for any errors or omissions.

PRICELIST

Bench



Item no. 633

Bench w/"V"				
Dimensions (cm)			Price (EUR)	
W	D	H	Ash	Oak
160	35	45		
180	35	45		
200	35	45		
220	35	45		
240	35	45		

Additional information

Plate thickness: 2 cm.**Steel profile: 2x2 cm.****Alternative size = surcharge.**

Stainless steel = + 10%

All prices are purchase prices in Euro.
We accept no liability for any errors or omissions.

PRICELIST

Shelf furniture



Item no. 634

Shelf unit				
Dimensions (cm)			Price (EUR)	
W	D	H	Ash	Oak
140	40	80		

Additional information

The shelf furniture are delivered assembled.

Stainless steel = + 10%

All prices are purchase prices in Euro.
We accept no liability for any errors or omissions.

PRICELIST

Desk w/2 "push" drawers



Item no. H75 635

Item no. H90 637

Desk w/2 drawers				
Dimensions (cm)			Price (EUR)	
W	D	H	Ash	Oak
100	40	75		
110	40	75		
120	40	75		
130	40	75		
150	40	75		

Night stand w/ 1 "push" drawer



Item no. 627

Night stand w/1 drawer				
Dimensions (cm)			Price (EUR)	
W	D	H	Ash	Oak
50	40	60		

Additional information

The shelf furniture are delivered assembled.

Stainless steel = + 10%

All prices are purchase prices in Euro.

We accept no liability for any errors or omissions.

PRICELIST

HIFI sideboard with textile and "push" doors/drawers

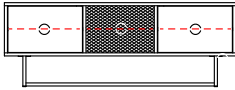
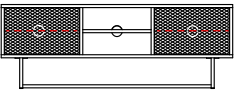
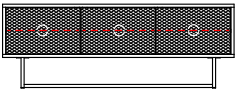
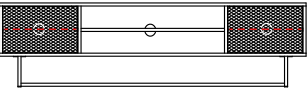
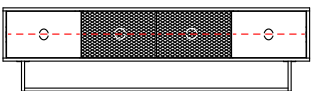

HIFI-sideboard with HIFI-fabric					
Description + drawing	Dimensions (cm)			Price (EUR)	
	W	D	H	Ash	Oak
item no. 6362 2 doors (veneer), 1 door (w/textile), 3 cable holes in the back 	151	40	55		
item no. 6363 2 doors (w/textile), 1 open space, 3 cable holes in the back 	151	40	55		
item no. 6364 3 doors (w/textile), 3 cable holes in the back 	151	40	55		
item no. 6367 2 doors (w/textile), 1 open space, 3 cable holes in the back 	200	40	55		
item no. 6366 2 doors (veneer), 2 doors (w/textile), 4 cable holes in the back 	200	40	55		

--- Wood shelf inside



Please note that we can not guarantee that the HIFI fabric works with all infrared devices.

Overview of which doors are left and right hinged on all ZET cabinets

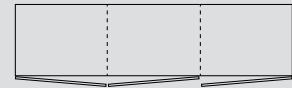

3 sections

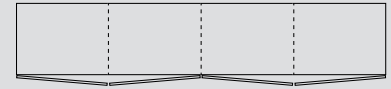

4 sections

Additional information

Plate thickness: 2 cm.

Steel profile: 2x2 cm.

Removable wooden shelves

- max. 20 kg - evenly distributed.

Adjustable shelves

The shelves can be adjusted a little bit up/down from the standard position.

Stainless steel = + 10%



All prices are purchase prices in Euro.

We accept no liability for any errors or omissions.

PRICELIST

Wallmounted HIFI sideboard with textile and "push" doors/drawers

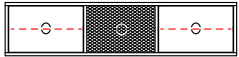

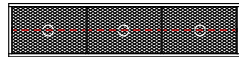
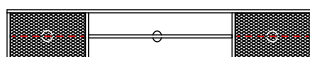
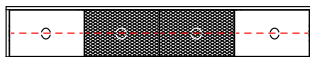
HIFI-sidebaord with fabric - wall mount					
Description + drawing	Dimensions (cm)			Price (EUR)	
	W	D	H	Ash	Oak
item no. 6362W 2 doors (veneer) 1 door (w/textile) 3 cable holes in the back 	151	42	35		
item no. 6363W 2 doors (w/textile), 1 open space 3 cable holes in the back 	151	42	35		
item no. 6364W 3 doors (w/textile) 3 cable holes in the back 	151	42	35		
item no. 6367W 2 doors (w/textile), 1 open space 3 cable holes in the back 	200	42	35		
item no. 6366W 2 doors (veneer) 2 doors (w/textile) 4 cable holes in the back 	200	42	35		

--- Wood shelf inside



Please note that we can not guarantee that the HIFI fabric works with all infrared devices.

Overview of which doors are left and right hinged on all ZET cabinets

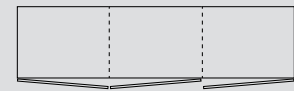

3 sections

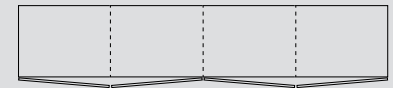

4 sections

Additional information

Plate thickness: 2 cm.

Steel profile: 2x2 cm.

Removable wooden shelves

- max. 20 kg - evenly distributed.

Adjustable shelves

The shelves can be adjusted a little bit up/down from the standard position.

Stainless steel = + 10%



All prices are purchase prices in Euro.

We accept no liability for any errors or omissions.

PRICELIST

HIFI sideboard "push" doors/drawer

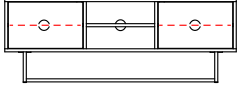

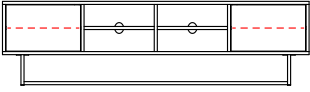
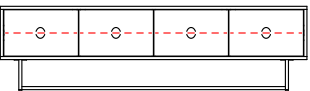
HIFI-sideboard					
Description + drawing	Dimensions (cm)			Price (EUR)	
	W	D	H	Ash	Oak
item no. 6373 2 doors (veneer) 1 open space 3 cable holes in the back 	151	40	55		
item no. 6374 3 doors (veneer) 3 cable holes in the back 	151	40	55		
item no. 6375 2 doors (veneer) 2 open spaces 4 cable holes in the back 	200	40	55		
item no. 6376 4 doors (veneer) 4 cable holes in the back 	200	40	55		

--- Wood shelf inside

Overview of which doors are left and right hinged on all ZET cabinets

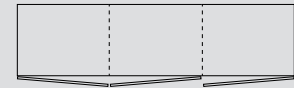

3 sections

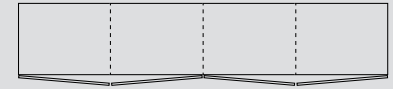

4 sections

Additional information

Plate thickness: 2 cm.

Steel profile: 2x2 cm.

Removable wooden shelves

- max. 20 kg - evenly distributed.

Adjustable shelves

The shelves can be adjusted a little bit up/down from the standard position.

Stainless steel = + 10%





All prices are purchase prices in Euro.

We accept no liability for any errors or omissions.

PRICELIST

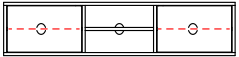
Wallmounted HIFI sideboard "push" doors/drawer



HIFI-sideboard - wall mount					
Description + drawing	Dimensions (cm)			Price (EUR)	
	W	D	H	Ash	Oak
item no. 6373W 2 doors (veneer) 1 open space 3 cable holes in the back 	151	42	35		
item no. 6374W 3 doors (veneer) 3 cable holes in the back 	151	42	35		
item no. 6375W 2 doors (veneer) 2 open spaces 4 cable holes in the back 	200	42	35		
item no. 6376W 4 doors (veneer) 4 cable holes in the back 	200	42	35		

--- Wood shelf inside

Overview of which doors are left and right hinged on all ZET cabinets

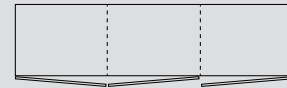

3 sections

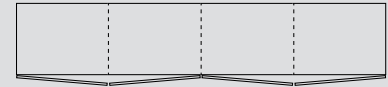

4 sections

Additional information

Plate thickness: 2 cm.

Steel profile: 2x2 cm.

Removable wooden shelves

- max. 20 kg - evenly distributed.

Adjustable shelves

The shelves can be adjusted a little bit up/down from the standard position.

Stainless steel = + 10%





All prices are purchase prices in Euro.

We accept no liability for any errors or omissions.

PRICELIST

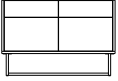
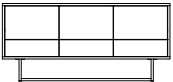
Sideboards w/push drawers + doors. Height 70 cm

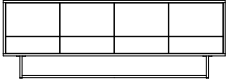

Sideboard H70 cm					
Description + drawing	Dimensions (cm)			Price (EUR)	
	W	D	H	Ash	Oak
item no. 6337 - 2 doors 	102	40	70		
item no. 6338 - 2 doors, 2 drawers 	102	40	70		
item no. 6343 - 3 doors, 3 drawers 	151	40	70		
item no. 6344 - 3 doors 	151	40	70		
item no. 6345 - 4 doors, 4 drawers 	200	40	70		
item no. 6346 - 4 doors 	200	40	70		

--- Wood shelf inside

Overview of which doors are left and right hinged on all ZET cabinets

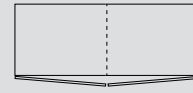

2 sections

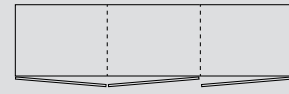

3 sections

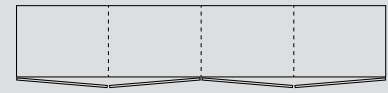

4 sections

Additional information

Plate thickness: 2 cm.

Steel profile: 2x2 cm.

Removable wooden shelves

- max. 20 kg - evenly distributed.

Adjustable shelves

The shelves can be adjusted a little bit up/down from the standard position.

Stainless steel = + 10%

All prices are purchase prices in Euro.

We accept no liability for any errors or omissions.

PRICELIST

Sideboards w/push drawers + doors. Height 85 cm

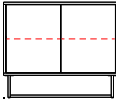
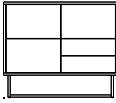
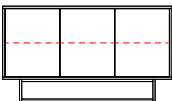
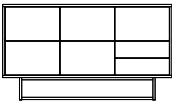
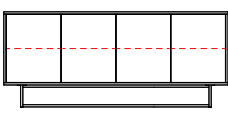
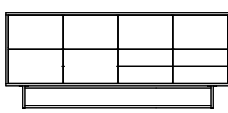

Sideboard H85 cm					
Description + drawing	Dimensions (cm)			Price (EUR)	
	W	D	H	Ash	Oak
item no. 6301 - 2 doors 	102	40	85		
item no. 6302 - 2 doors, 2 drawers 	102	40	85		
item no. 6303 - 3 doors 	151	40	85		
item no. 6304 - 5 doors, 2 drawers 	151	40	85		
item no. 6305 - 4 doors 	200	40	85		
item no. 6306 - 6 doors, 4 drawers 	200	40	85		

--- Wood shelf inside

Overview of which doors are left and right hinged on all ZET cabinets

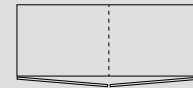

2 sections

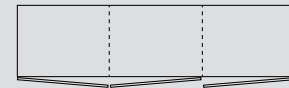

3 sections

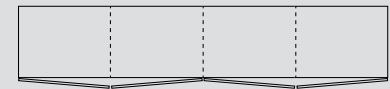

4 sections

Additional information

Plate thickness: 2 cm.

Steel profile: 2x2 cm.

Removable wooden shelves

- max. 20 kg - evenly distributed.

Adjustable shelves

The shelves can be adjusted a little bit up/down from the standard position.

Stainless steel = + 10%

All prices are purchase prices in Euro.

We accept no liability for any errors or omissions.

PRICELIST

Glass cabinet w/handles on the glass doors.



BI
Handle in black steel



MI
Handle in brass

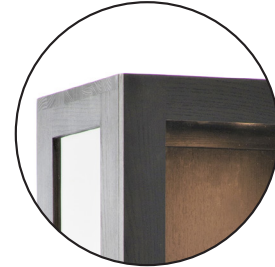

The glass doors are mounted on the outer side of the corpus.
Only on item no. 6347 + 6348!

Overview of which doors are left and right hinged on all ZET cabinets

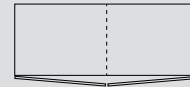

2 sections

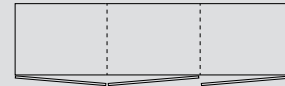

3 sections

Additional information

Plate thickness: 2 cm.

Steel profile: 2x2 cm.

Removable glass shelves.

- max. 12 kg - evenly distributed.

LED light in top of the cabinet.

Adjustable shelves.

The shelves can be adjusted a little bit up/down from the standard position.

Soft close

The glass doors with handles are with soft close.

● *Handles - See options on page. 31*

--- *Wood shelf inside*

We use tempered glass on our vitrines

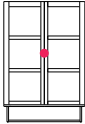
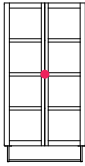
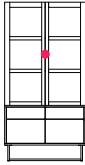
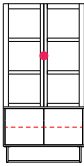
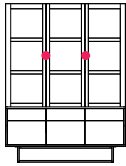
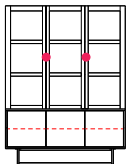
Vitrine					
Description + drawing	Dimensions (cm)			Price (EUR)	
	W	D	H	Ash	Oak
item no. 6357O - 2 doors 	102	40	157		
item no. 6347O - 2 doors 	102	40	200		
item no. 66348O - 4 doors, 2 drawers 	102	40	200		
item no. 6353O - 4 doors 	102	40	200		
item no. 6354O - 6 doors, 3 drawers 	151	40	200		
item no. 6352O - 6 doors 	151	40	200		

Stainless steel = + 10%

All prices are purchase prices in Euro.

We accept no liability for any errors or omissions.

WOOD COLOURS



Images for guiding purpose only!

The wood structure and colour will vary from ash and oak.

We therefore recommend using the wood samples/exhibition furniture to get a more accurate impression.



ASH C3 / OAK C3
Lacquered

We treated this wood with lacque.

C3 are only made for products without patination.



ASH C4 / OAK C4
Natural oiled

We treated this wood with our 'Natural oil'.



ASH C6 / OAK C6
White oiled

We treated this wood with our 'White oil'.



ASH C8 / OAK C8
Soaped

We treated this wood with soap.



ASH C11 / OAK C11
Dark grey oiled

We treated this wood with our 'Black oil'.



ASH C12 / OAK C12
Antique brown oiled

We treated this wood with our 'Antique brown oil'.



ASH C13 / OAK C13
Light grey oiled

We treated this wood with our 'Light grey oil'.



ASH C14 / OAK C14
Black stained & oiled

We treated this wood with black stain, and treated it with a wax oil.

C14 is for legs and storage furniture only!



ASH C15 / OAK C15
Mocca brown oiled

We treated this wood with our 'Mocca brown oil'.



ASH C16
Warm white oiled

We treated this wood with our 'Warm white oil'.

C16 is only for ash



ASH C20 / OAK C20
Grey brown oiled

We treated this wood with our 'Grey brown oil'.



ASH C44 / OAK C44
Black matt lacquered

We treated this wood with black stain, and treated it with matt lacque.

C44 is only for plates and can only be made for products without patination.



For more information about maintenance, please visit our website:
WWW.KRISTENSEN.COM



We also offers our own repairoils for our products
- contact us if you need a pricelist.

Stainless steel = + 10%

All prices are purchase prices in Euro.
We accept no liability for any errors or omissions.

WOOD FINISH



UP

Without patination

The wood is planned and sanded to achieve a smooth surface.

With few and smaller knots.

Storage furniture can only be made with this finish!



SC

Soft Cracks

Naturally occurring cracks are made more visible which gives a rustic look with cracks in the surface.

May contain more and larger knots.

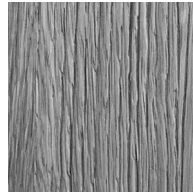

RL

Raw Look

We brush off the layer of softer wood which gives a look of wood that has been roughened by natural wear.

May contain more and larger knots.



FK

Filled Knots

The knots are filled and the wood is planned and sanded to achieve a smooth surface.

Only for OAK!

STEEL COLOUR & FINISH

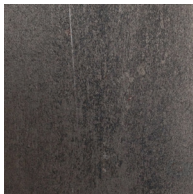

A

Industrial steel

Industrial steel has a raw and matte appearance with shades of colors emerged during casting.

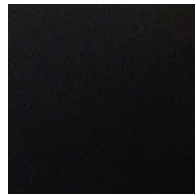

B

Black painted steel

Black painted steel has a graphical and simple look, that fits nicely in most homes.

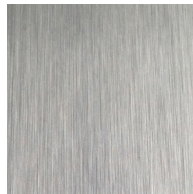

C

Brushed stainless steel

Brushed, stainless steel has an elegant appearance with a uniform finish created by hand.

Extra cost!

HANDLES



BI

I-handles in blackpainted steel



MI

I-handles in brass

Stainless steel = + 10%

All prices are purchase prices in Euro.

We accept no liability for any errors or omissions.

MEASURES

Measures for estimating the number of chairs fitting around these tables

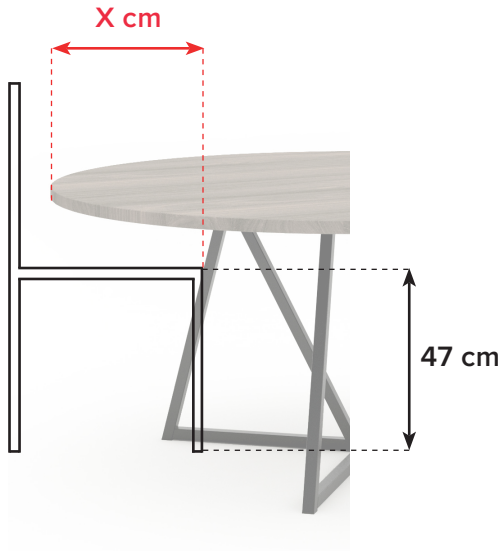

ITEM NO. 641V

Ø100	X = 26,5 cm
Ø110	X = 31,5 cm
Ø120	X = 31,5 cm
Ø130	X = 31,5 cm
Ø140	X = 31,5 cm
Ø150	X = 31,5 cm
Ø160	X = 31,5 cm

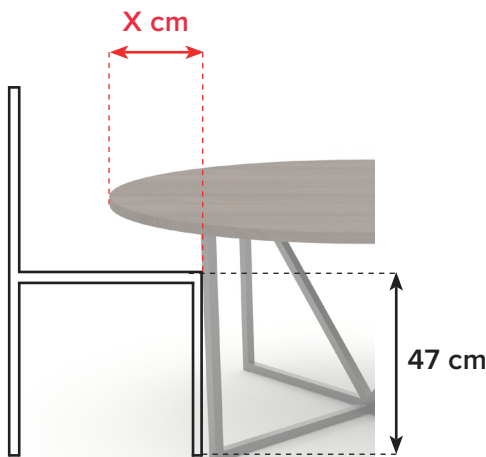

ITEM NO. 641

Ø100	X = 14 cm
Ø110	X = 14 cm
Ø120	X = 14 cm
Ø130	X = 14 cm
Ø140	X = 14 cm
Ø150	X = 14 cm
Ø160	X = 14 cm

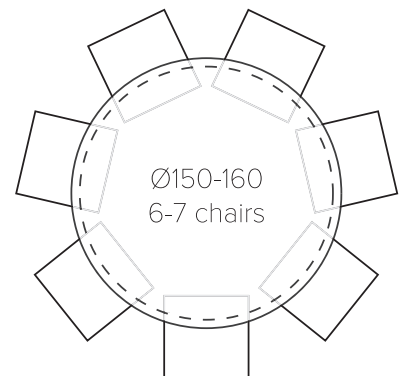
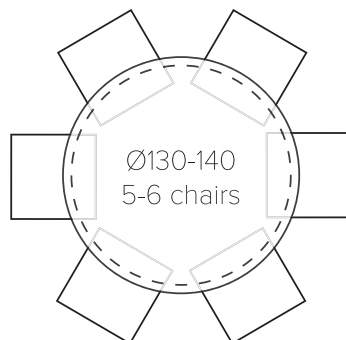
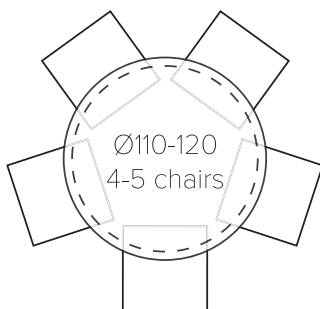

Stainless steel = + 10%

All prices are purchase prices in Euro.
We accept no liability for any errors or omissions.

CONTACT

CUSTOMISED TABLES

We are able to produce all our table types in special sizes. Furniture in special sizes requires special handling both in terms of manual handling, new drawings, machine settings and packaging. We therefore include a sur-charge for products in special sizes, whether the product will be larger or smaller. If you want a table in a smaller size e.g, the price is added 15% on the price of the nearest standard size.

Contact us for more information!

Agent, Norway

Paal Stenvaag

—

✉ post@mobelpaal.no

☎ +47 926 18 628

Agent, Finland

Jokko Salmevaara

—

✉ jokko.salmevaara@boknas.fi

☎ +358 401 958 886

Sweden

Steen Tokkesdal (temporarily)

—

✉ st@kristensen.dk

☎ +45 41 22 00 22

Agent, UK

Brendan Brett

—

✉ kristensen@theukagency.co.uk

☎ +44 77 34 265 599

Head office, Denmark

PHONE:

+45 75470303

ORDER MAIL:

order@kristensen.dk

ADDRESS:

Kristensen & Kristensen A/S
Storstrømsvej 44
6715 Esbjerg N
DK - Denmark

TERMS & CONDITIONS

—

Can be sent via email by
request – contact:

kristensen@kristensen.com

WEBSITE:

www.kristensen.com

CLAIMS:

claim@kristensen.dk

MAIL:

kristensen@kristensen.dk

FAX:

+45 75470304

