

Range
—
OPTIC



—
PRICELIST
PRESS

—
EXPORT
01.09.2024



Range

OPTIC

OPTIC is a series of simple and understated designs with an edge. Here we focus on clean lines in an updated format with a timeless quality.

Designed by

Cecilie Kamp

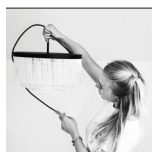

This range include

Dining tables
Coffee tables
HIFI-sideboards
Shelves

Features



Design elements

Choose from different designs and add ons.



Custommade

In addition to our many standard options we can accommodate special requests.



Wood colours

Choose between more than 10+ different wood colours in both ash and oak.



Sustainable choice

Solid wood furniture can last a lifetime with proper maintenance

Social media

Follow and share with us on Instagram.

 @kristensenfurniture | #kristensenfurniture

Pricelist- and imagebank

On our Collection-site you as a retailer always have access to the latest pricelists and hundreds of high resolution images and videos
- **Free to use in your marketing!**

If you do not have a password yet, please contact the Kristensen sales office in Denmark.

LINK:

collection.kristensen.com

PRICELIST

Round dining table (undivided)



PRICE (EUR)

OPTIC round undivided dining table H74 cm w/3 cm wooden plate

D (cm)	Description	Item no.	ASH	OAK
140	Undivided plate	OP3H-140	940	1.175
130	Undivided plate	OP3H-130	883	1.104
120	Undivided plate	OP3H-120	831	1.039
110	Undivided plate	OP3H-110	811	1.039



Edge profile 1

Harlekin



Edge profile 2

Arched



Edge profile 3

Pisa (rounded)



Edge profile 4

Straight

PRICELIST

Round dining table (extendable)



PRICE (EUR)				
OPTIC extendable round dining table H74 cm w/3 cm wooden plate				
D (cm)	Description	Item no.	ASH	OAK
140	Extension for 4 leaves*	OP3M-140		
130	Extension for 4 leaves*	OP3M-130		
120	Extension for 4 leaves*	OP3M-120		
110**	Extension for 4 leaves*	OP3M-110**		

* Comes with 2 support legs

** The extension system is 8 cm from the edge!

PRICE (EUR)				
OPTIC leaf for extendable round dining table, 3 cm plate thickness				
Size (cm)	Description	Item no.	ASH	OAK
50x140	Leaf 50x140 cm	OPT3-140		
50x130	Leaf 50x130 cm	OPT3-130		
50x120	Leaf 50x120 cm	OPT3-120		
50x110	Leaf 50x110 cm	OPT3-110		



Edge profile 1

Harlekin



Edge profile 2

Arched



Edge profile 3

Pisa (rounded)



Edge profile 4

Straight

PRICELIST

Round coffee table w/wooden top



PRICE (EUR)						
OPTIC round coffee table w/2 cm wooden plate (item no.: OPCR2)						
D (cm)	H 36 cm		H 42 cm		H 48 cm	
	ASH	OAK	ASH	OAK	ASH	OAK
100						
88						
76						
60						

Standard sizes

Height:

- H36, 42 or 48 cm

Floor to cross bar:

- H36 = 8, H42 = 10, H48 = 12 cm

Special sizes

Other height:

- Standard price +20%

Other size:

- Ask for price (max diameter 100)

PRICELIST

Round coffee table w/glass



PRICE (EUR)						
OPTIC round coffee table w/glass (item no.: OPCRG)						
D (cm)	H 36 cm		H 42 cm		H 48 cm	
	ASH	OAK	ASH	OAK	ASH	OAK
100						
88						
76						
60						

Standard sizes

Height:

- H36, 42 or 48 cm

Floor to cross bar:

- H36 = 8, H42 = 10, H48 = 12 cm

Special sizes

Other height:

- Standard price +20%

Other size:

- Only made in standard diameter!

PRICELIST

Square coffee table w/wooden "tray" (not removable)



PRICE (EUR)				
OPTIC coffee table w/wooden "tray" (item no.: OPCSW)				
L x B (cm)	H 42 cm		H 48 cm	
	ASH	OAK	ASH	OAK
77 x 77				
67 x 67				

Standard sizes

Height:
- H42 or 48 cm

Floor to cross bar:
- H42 = 16, H48 = 16 cm

Special sizes

Other height:
- Standard price +20%

Other size:
- Ask for price

PRICELIST

Square coffee table w/glass & storage room



PRICE (EUR)				
<i>OPTIC square coffee table w/glass (item no.: OPCSG)</i>				
L x W (cm)	H 42 cm		H 48 cm	
	ASH	OAK	ASH	OAK
77 x 77				
67 x 67				

Standard sizes

Height:
- H42 or 48 cm

Floor to cross bar:
- H42 = 16, H48 = 16 cm

Special sizes



Other height:
- Standard price +20%

Other size:
- Only made in standard width x length!

PRICELIST

Wall mount HIFI-sideboard

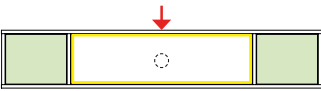
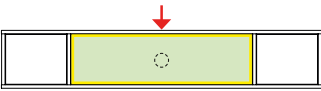
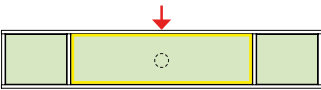
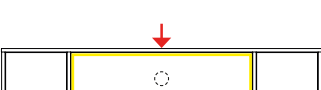
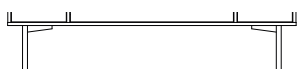

HIFI-SIDEBOARD (veneered)						
Description	Item no.	Size (cm)			Price (EUR)	
		B	D	H	ASH	OAK
 HIFI-sideboard (wallmount)	OPH1	176	30	32		
 HIFI-sideboard (wallmount)	OPH2	176	30	32		
 HIFI-sideboard (wallmount)	OPH3	176	30	32		
 HIFI-sideboard (wallmount)	OPH4	176	30	32		
 Wooden legs (for OPH1-OPH4)	OPHLW	176	30	28		
 Steel legs (for OPH1-OPH4)	OPHLS	176	30	28		

 Flip door

 Front w/HIFI fabric

 Rear wall w/ hole for cables

 Hole for wires, centered at the top towards the wall



HIFI FABRIC

Green colour

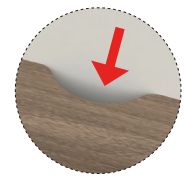

WIRING WITHDRAWAL

Red arrow



WOOD LEG

OPHLW



STEEL LEG

OPHLS

PRICELIST

Wall mount shelves

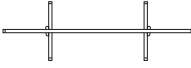
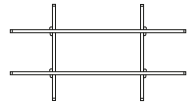
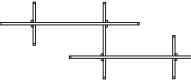
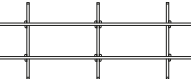
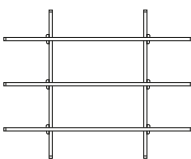
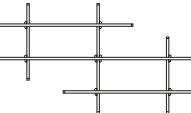

SHELVES (solid)						
Description	Item no.	Size			Price	
		B	D	H	ASH	OAK
	OPNS1	117	18	36		
	OPNS2	117	18	64		
	OPNS3	175	18	64		
	OPNS4	175	18	64		
	OPNS5	117	18	92		
	OPNS7	175	18	92		

Standard sizes only.

WOOD COLOURS

Images for guiding purpose only!

The wood structure and colour will vary from ash and oak.

We therefore recommend using the wood samples/exhibition furniture to get a more accurate impression.



ASH C3 / OAK C3
Lacquered

We treated this wood with lacque.

C3 are only made for products without patination.



ASH C4 / OAK C4
Natural oiled

We treated this wood with our 'Natural oil'.



ASH C6 / OAK C6
White oiled

We treated this wood with our 'White oil'.



ASH C8 / OAK C8
Soaped

We treated this wood with soap.



ASH C11 / OAK C11
Dark grey oiled

We treated this wood with our 'Black oil'.



ASH C12 / OAK C12
Antique brown oiled

We treated this wood with our 'Antique brown oil'.



ASH C13 / OAK C13
Light grey oiled

We treated this wood with our 'Light grey oil'.



ASH C14 / OAK C14
Black stained & oiled

We treated this wood with black stain, and treated it with a wax oil.

C14 is for legs and storage furniture only!



ASH C15 / OAK C15
Mocca brown oiled

We treated this wood with our 'Mocca brown oil'.



ASH C16
Warm white oiled

We treated this wood with our 'Warm white oil'.

C16 is only for ash



ASH C20 / OAK C20
Grey brown oiled

We treated this wood with our 'Grey brown oil'.



ASH C44 / OAK C44
Black matt lacquered

We treated this wood with black stain, and treated it with matt lacque.

C44 is only for plates and can only be made for products without patination.



For more information about maintenance, please visit our website:
WWW.KRISTENSEN.COM



We also offers our own repairoils for our products
- contact us if you need a pricelist.

PRICELIST

Lazy Susan – turntable (rotating tray)

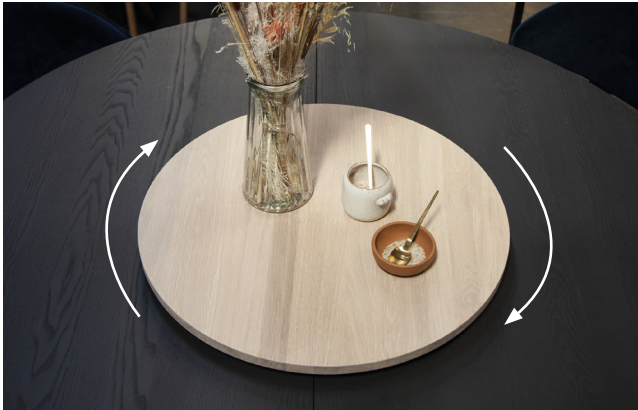

The plate has a turning function.
The product can be used with all our round dining tables.

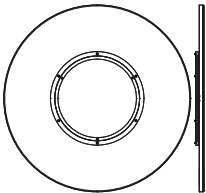
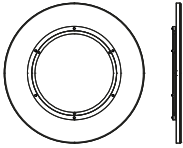
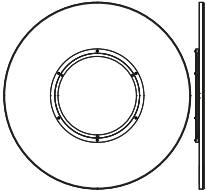
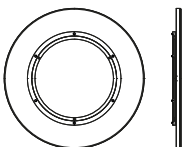

Price: LAZY SUSAN, plate thickness 2 cm				
description	item no.	measure (cm)		price (EUR)
		D	H	
 Lazy Susan turning plate in ASH	LAZY-80	80	4	206
 Lazy Susan turning plate in ASH	LAZY-60	60	4	181
 Lazy Susan turning plate in OAK	LAZY-80	80	4	278
 Lazy Susan turning plate in OAK	LAZY-60	60	4	234

Edge profile for LAZY SUSAN



4
Straight edge

MEASURES

*Space for the chair opposite the table leg
- in all the different table sizes*

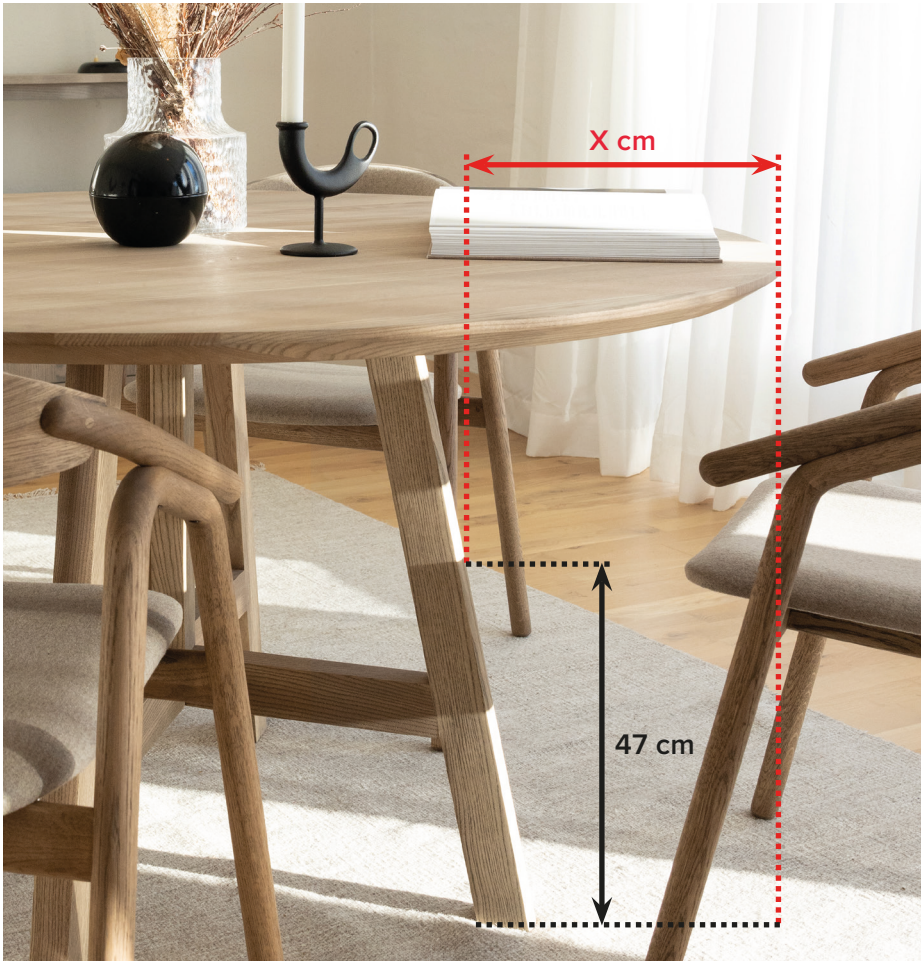

OPTIC DINING TABLE

Ø110 X = 22 cm

Ø120 X = 27 cm

Ø130 X = 32 cm

Ø140 X = 37 cm

*Estimated number of chairs fitting around
the table - when the chair is 50 cm wide*

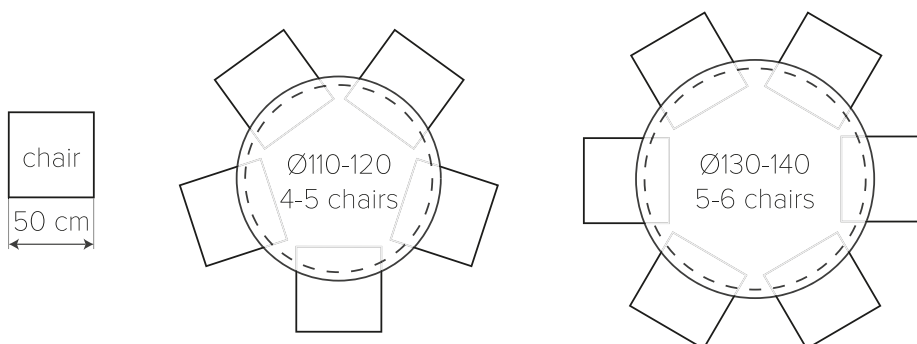

CONTACT

CUSTOMISED TABLES

We are able to produce all our table types in special sizes. Furniture in special sizes requires special handling both in terms of manual handling, new drawings, machine settings and packaging. We therefore include a surcharge for products in special sizes, whether the product will be larger or smaller. If you want a table in a smaller size e.g, the price is added 15% on the price of the nearest standard size.

Contact us for more information!

Agent, Norway

Paal Stenvaag

—

✉ post@mobelpaal.no

☎ +47 926 18 628

Agent, Finland

Jokko Salmevaara

—

✉ jokko.salmevaara@boknas.fi

☎ +358 401 958 886

Agent, Sweden

Anne Moberg

—

✉ am@kristensen.dk

☎ +46 707580279

Agent, UK

Brendan Brett

—

✉ kristensen@theukagency.co.uk

☎ +44 77 34 265 599

Head office, Denmark

PHONE:

+45 75470303

ORDER MAIL:

order@kristensen.dk

ADDRESS:

Kristensen & Kristensen A/S
Storstrømsvej 44
6715 Esbjerg N
DK - Denmark

TERMS & CONDITIONS

—

Can be sent via email by request – contact:

kristensen@kristensen.com

WEBSITE:

www.kristensen.com

CLAIMS:

claim@kristensen.dk

MAIL:

kristensen@kristensen.dk

FAX:

+45 75470304

